

FL250 Floorline Bed

Low Height, High Style



FL250 Floorline Bed



FL250 Bed Included Features

- 1 250kg SWL
- 2 110mm Low Height / 740mm Max Height
- 3 Single and King Single Sizes
- 4 Four Section Wipe Clean Mattress Platform
- 5 Powered Backrest from 0 - 60°
- 6 Powered Knee Break from 0 - 35°
- 7 Auto-Regression in Backrest and Knee Break for Shear-Force Reduction
- 8 Trendelenburg (pictured) / Reverse Trendelenburg
- 9 Handset and Attendant Control Panel - Both Backlit and Lockable (Supplied With Bed Ends)
- 10 Underbed Lighting for Falls Prevention
- 11 Intelligent Wall Protection Buffer
- 12 Integrated Bed Extension to 100mm and 200mm
- 13 Mattress Retainers at Sides and Foot End (Extendable)
- 14 In-Line Central Locking Brakes
- 15 Stylish, Customisable and Bespoke Bed Ends and Sides
- 16 One Button Chair Positioning
- 17 One Button Optimum Ingress / Exit and CPR Height
- 18 Full Range of Performance Enhancing Accessories

Resident & Carer Safety

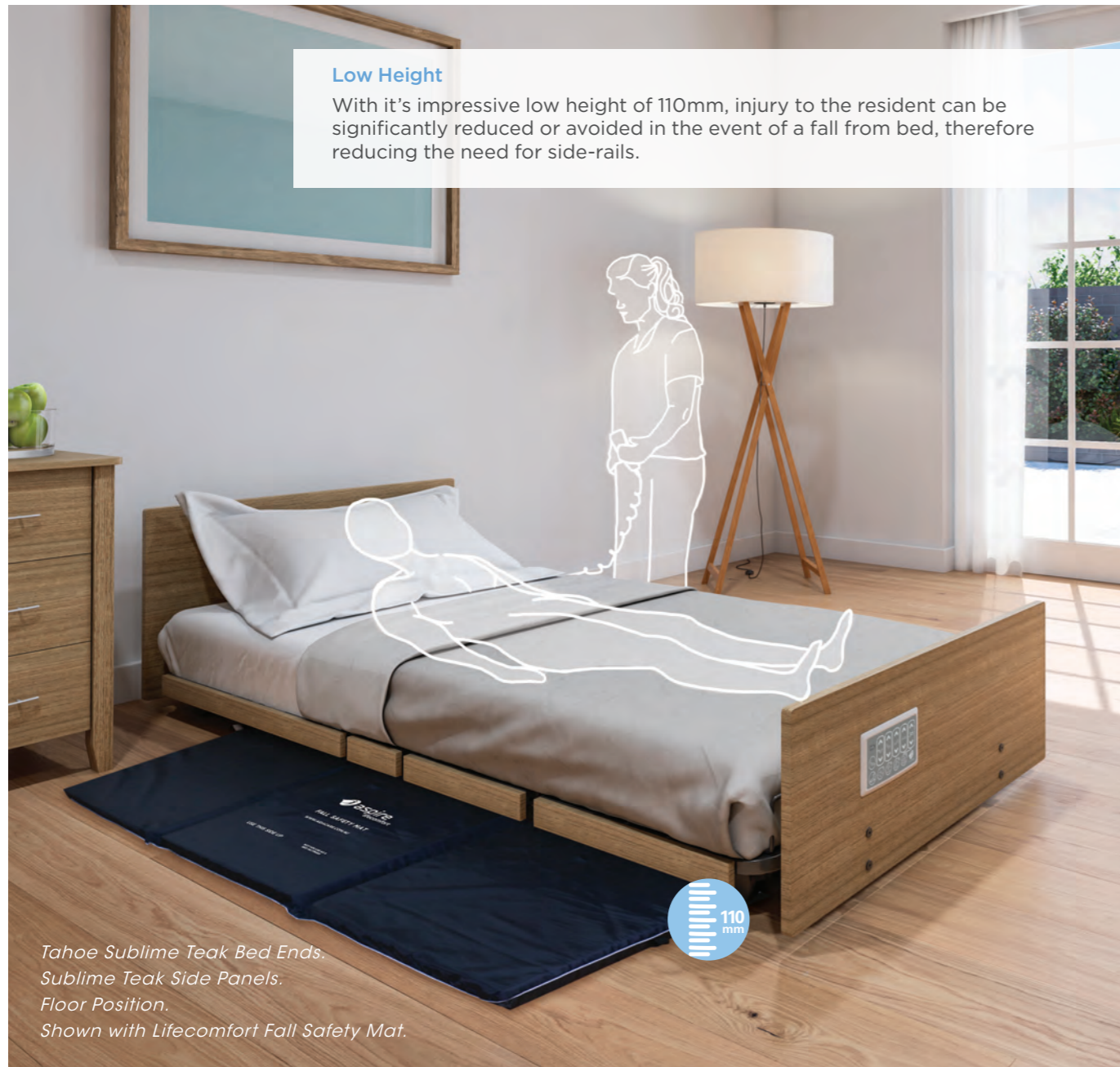

Low Height

With its impressive low height of 110mm, injury to the resident can be significantly reduced or avoided in the event of a fall from bed, therefore reducing the need for side-rails.

Tahoe Sublime Teak Bed Ends.
Sublime Teak Side Panels.
Floor Position.
Shown with Lifecomfort Fall Safety Mat.

Attendant Control Panel

Allows the caregiver to lock out certain functions and also ensures bed operation is not just restricted to the handset.



Comes with Bed End Sets that are Sold Separately

Under Bed Clearance

While the FL250 achieves a low height of 110mm, full clearance under the bed is still maintained, minimising the risk of foot or cord impingement.

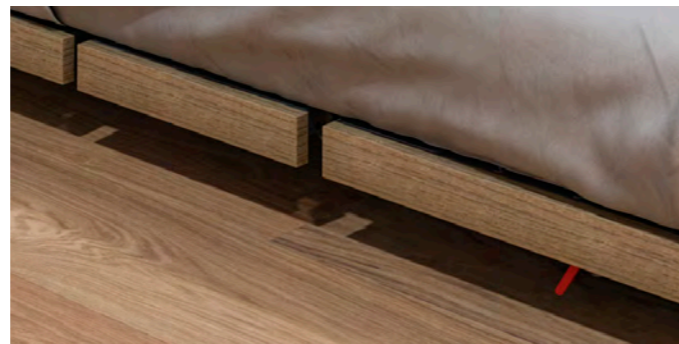

In Australian Aged Care Facilities, 1 in 2 residents fall each year. The bedside is the most common location for these falls.



While falls can often be difficult to prevent, risk factors can be identified and strategies to reduce harm can be implemented. Sleeping low is a proven good strategy.

ExitSafe

By pushing the ExitSafe button the FL250 moves to a flat and ergonomic position at the optimum height for resident ingress / exit.



Lockable Functions



BrakeFirst

Brakes automatically lock when bed reaches its lowest height. Brakes are located within the footprint of the bed, minimising any trip hazard for the caregiver and resident alike. Brakes are easily accessible at all heights.



SmartDescent

Automatically slows descent speed over the final 300mm of lowering to the floor level, allowing possible impingements to be identified and moved.



Underbed Lighting

Allows discreet visibility and safety at night.

Clinical Considerations

Introducing AutoRegression

AutoRegression helps to reduce sacral pressure, shear forces and abdominal compression during bed profiling.

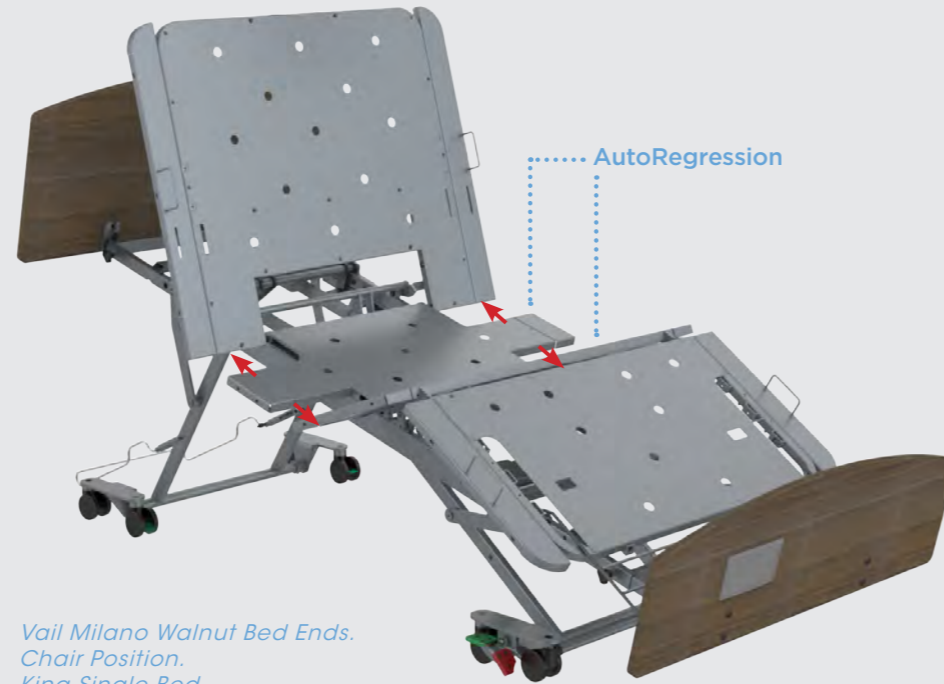
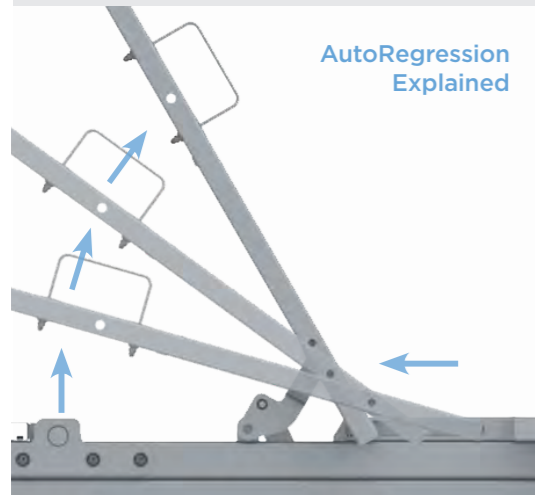

Vail Milano Walnut Bed Ends.
Chair Position.
King Single Bed.

CPR Position

The low height and flat surface of the ExitSafe position also facilitates the administration of CPR in the event of an emergency.



Chair Positioning

For improved pressure management and respiration. Also a more comfortable dining and sitting position.

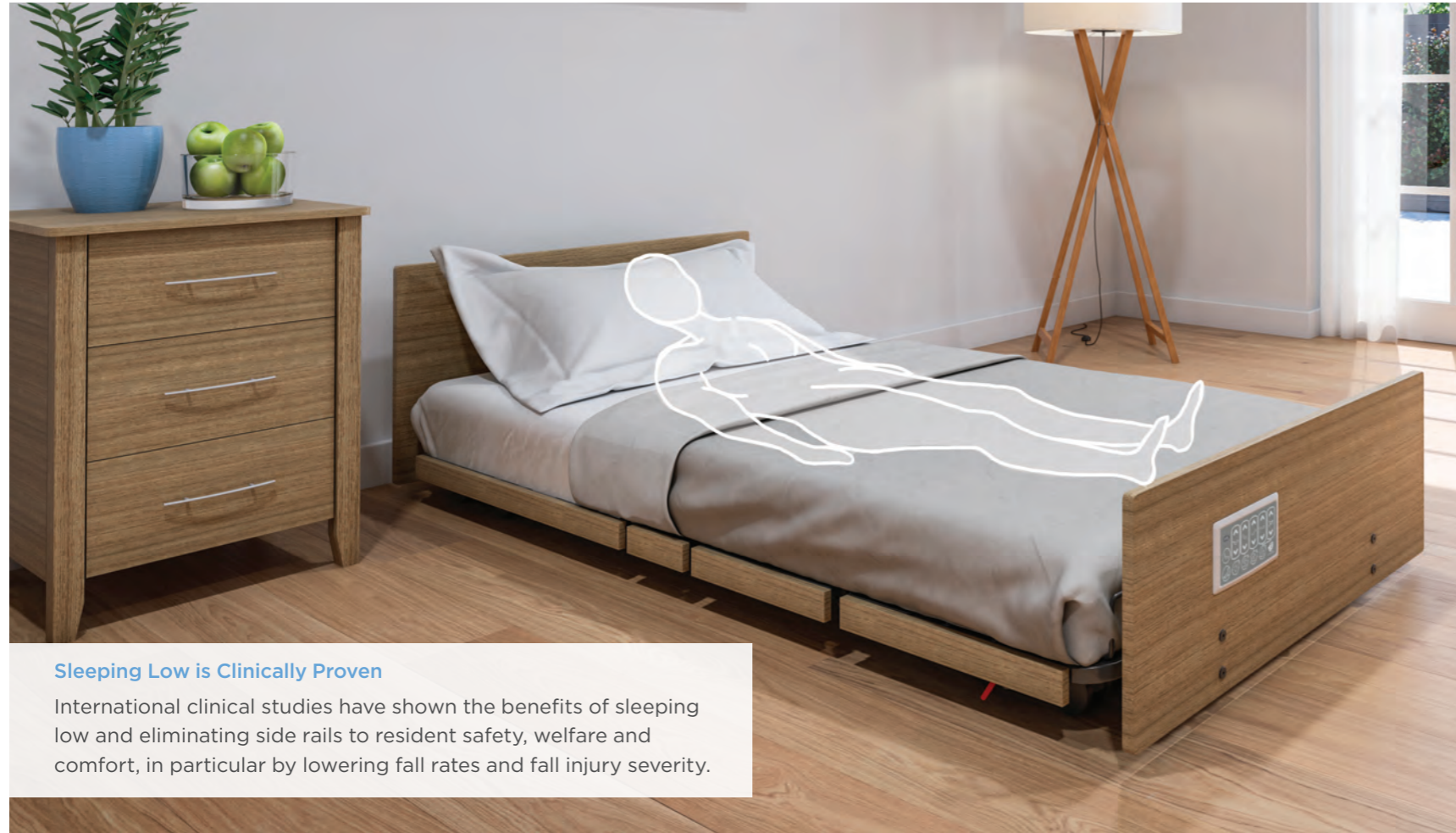

Sleeping Low is Clinically Proven

International clinical studies have shown the benefits of sleeping low and eliminating side rails to resident safety, welfare and comfort, in particular by lowering fall rates and fall injury severity.

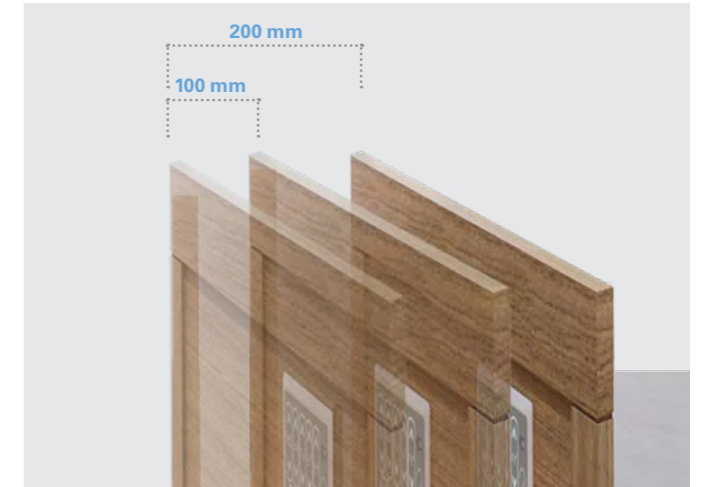

Extendable Patient Surface

Integrated bed extension to 100mm or 200mm including foot end mattress retainer.



Full +/- Trendelenburg Functionality

Interior Design & Finishes

High Style

The FL250 Bed incorporates a sophisticated range of finishing options. From our contemporary stock selection and made to order styles through to completely bespoke, any interior design desires can be met.

Standard Bed Ends



Standard Side Panels

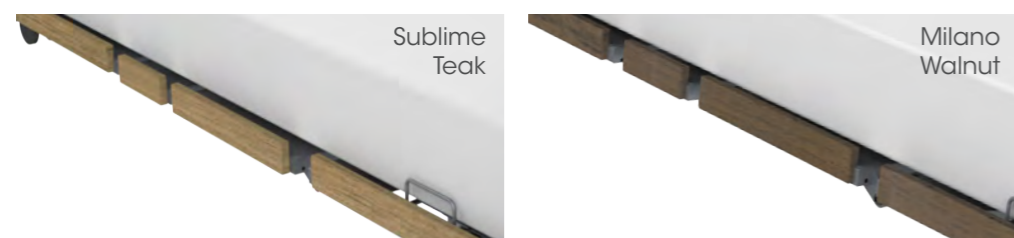

Made to Order Bed Ends



Bed Side Panels are also available to match Made to Order Bed End colours and finishes. Materials may vary.

Bespoke Finishes

Don't see a Stock or Made to Order design that suits your needs? We can customise as required to incorporate your choice of material, colour, finish, size or shape and match any interior design specifications.

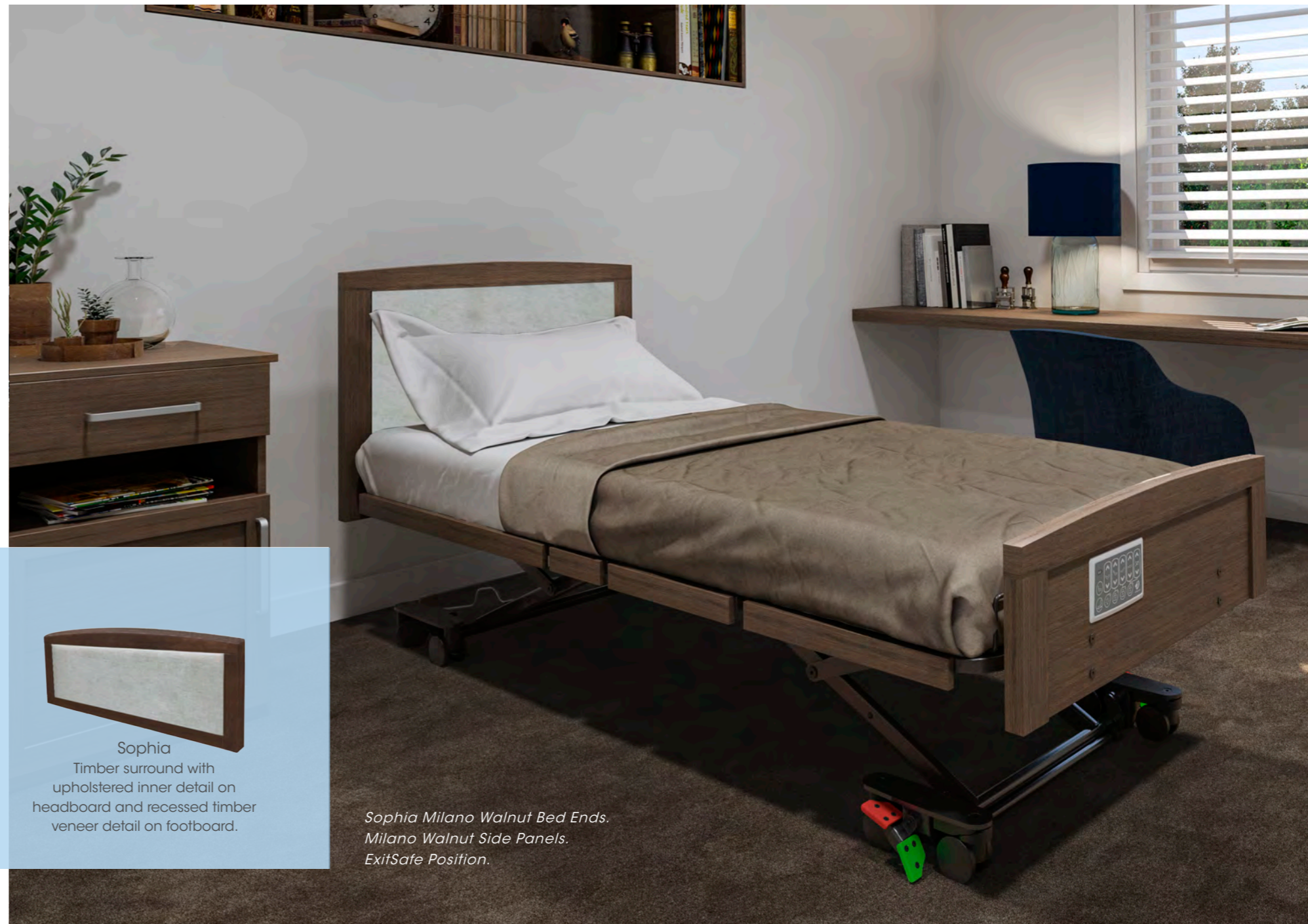

Customise to suit your interior design specifications or desires - timber, veneer, laminate, fabric, upholstery, any colours, shapes and sizes.

Technical Specifications

Standards Compliance

Aidacare FL250 Beds are designed and manufactured where required in compliance with International Medical Device Safety standard IEC60601-1, IEC60601-2-52. All electronics are designed for use in Acute Care environments and comply with all relevant Electrical Safety Standards.



Technical Specifications

Patient Surface - Single	2000mm x 900mm
Patient Surface - King Single	2000mm x 1060mm
Overall Length	2088mm to 2288mm
Length Extension	100mm / 200mm
Overall Width - Single	900mm
Overall Width - King Single	1060mm
Patient Surface Height Range	110mm to 740mm
Safe Working Load	250kg
Backrest Range	0 - 60°
Knee Bend Range	0 - 35°
Underbed Clearance	Variable. Minimum 30mm
Mattress Platform	4 Sections
Product Weight - Single	105kg
Product Weight - King Single	115kg
Castors	8 x Twin 75mm

Comprehensive user manual, troubleshooting guide, safety checklist, assembly instructions available.

Electrical Parameters

Power Input	230V AC 50Hz, Max current 1A
Rate Load	Interruption 10%, Max 2 minutes / 18 minutes
Leakage Protection	Class 1 Type B
Waterproof Grade	IP54

Performance Enhancing Accessories



BEA030050
EasyMove Transport System

The EasyMove Transport System is an ideal transport solution designed to minimise manual handling. It allows effortless lifting and tilting of the bed to its transport position, while the large 100mm castors offer smooth and easy manoeuvring for one person. The EasyMove is also a perfect maintenance platform facilitating easy access to mechanical parts under the bed platform.



BEB046525
Split folding Side Rails (Pair)

Left/Right pair of moulded rails provides manoeuvring assistance to a resident and/or a safety barrier. Can be positioned at the head end, foot end or a pair at both ends. Folds down to lowest position beside the bed platform.



BEB046520
Folding Assist Bar

Provides manoeuvring assistance to a resident. Folds down when not in use, out of the way of transfers.



BEB046540
Self Help Pole

The Self Help Pole provides manoeuvring and raising support to a resident. The Self Help Pole holder facilitates varied positioning and is securely attached behind the bed head.



BEB046530
IV Pole

The height adjustable IV Pole can also be manoeuvred within its holder, which is discreetly attached behind the bed head.

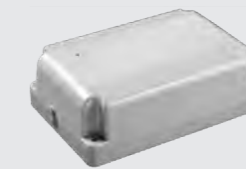

BEB046590
Battery Backup

Battery Backup is a recommended safety option to prolong bed operation by up to 15 lifts during a power outage.

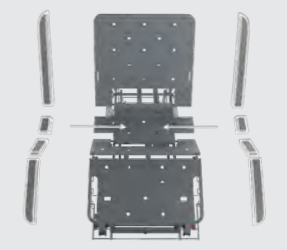

BEB046500
Width Extension Kit

Allows conversion of a Single FL250 into a King Single. Note - King Single FL250 Bed also sold separately.

Product Codes

BEB046100	FL250 Floorline Bed - Single
BEB046150	FL250 Floorline Bed - King Single

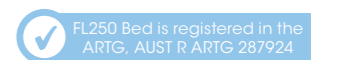

Bed End Sets - Includes Attendant Control Panel (Sold Separately)

BEB046200	Bed End Set - Single - Tahoe (Sublime Teak)
BEB046210	Bed End Set - Single - Vail (Milano Walnut)
BEB046220	Bed End Set - King Single - Tahoe (Sublime Teak)
BEB046230	Bed End Set - King Single - Vail (Milano Walnut)

Bed Side Panels - Also Choose Appropriate Size Attachment Hardware

BEB046240	Bed Side Panels - Tahoe (Sublime Teak) - Hardware separate
BEB046250	Bed Side Panels - Vail (Milano Walnut) - Hardware separate
GSP391630	Bed Side Panels Attachment Hardware - Single Bed
GSP391640	Bed Side Panels Attachment Hardware - King Single Bed

10
Year
Warranty

Frame

3
Year
Warranty

Electronics

1
Year
Warranty

Handset &
Cables

FL250 Floorline Bed - Low Height, High Style

Interior Fit-Out Concepts



Speak to our Experts about Interior Concepts and Architecturally designed layouts with 3D Imaging

Accompanying Equipment & Furniture

Standard & Pressure Care Mattresses



Over Bed Tables



Bedside Cabinets



Lifters & Slings



Pressure Chairs



Shower Commodes



ABB07.30.260719

Please speak to us about your made to order furniture requirements. Visit our website to review our comprehensive range of equipment.

1300 133 120
www.aidacare.com.au

 **aidacare**
FL250 FLOORLINE BED